



## STABILITY PROBLEMS OF STEEL-CONCRETE MEMBERS COMPOSED OF HIGH-STRENGTH MATERIALS

Zdeněk Kala<sup>1</sup>, Libor Puklický<sup>2</sup>, Abayomi Omishore<sup>3</sup>, Marcela Karmazínová<sup>4</sup>, Jindřich Melcher<sup>5</sup>

<sup>1,2,3</sup>Brno University of Technology, Faculty of Civil Engineering, Institute of Structural Mechanics,  
Veveří Str. 95, 602 00 Brno, Czech Republic

<sup>4,5</sup>Brno University of Technology, Faculty of Civil Engineering, Institute of Metal and Timber Structures,  
Veveří Str. 95, 602 00 Brno, Czech Republic

E-mails: <sup>1</sup>kala.z@fce.vutbr.cz; <sup>2</sup>l.puklicky@seznam.cz; <sup>3</sup>omishore.a@fce.vutbr.cz;  
<sup>4</sup>karmazinova.m@fce.vutbr.cz; <sup>5</sup>melcher.j@fce.vutbr.cz

Received 22 Sept. 2009; accepted 03 May 2010

**Abstract.** The presented paper deals with the stochastic analysis of the ultimate limit states of steel-concrete building members. The load carrying capacity of steel-concrete columns, comprising of steel profiles encased in high strength concrete, in compression is analyzed. The first part of the paper lists assumptions for the determination of the theoretical load carrying capacity of the column. Principles of elasticity and plasticity are used to determine stresses in the concrete and steel sections. Statistical characteristics of input material and geometrical imperfections are listed. Results of the theoretical analysis are then compared with results of experimental research. Statistical characteristics of obtained results of the theoretical analysis were verified using statistical characteristics obtained from experimental research. Numerical simulation LHS and Monte Carlo methods, which take into account the influences of variability of input imperfections, were employed. The influence of the utilization of the plastic reserve in the determination of the load carrying capacity of the analysed strut is shown. The influence of the initial geometric imperfections of initial strut curvature on the load carrying capacity is also presented.

**Keywords:** material, steel, concrete, structure, imperfections, failure, random, reliability.

### 1. Introduction

Progress in the determination of actual behaviour of load bearing structural systems, their limit states and failure mechanisms and the subsequent formulation of principles of design and realization are first and foremost based on the basic spectrum of progressive materials and their combination. Development of modern progressive materials with qualitatively higher properties and their practical applications are seen in the field of civil engineering structures where high-strength materials are now more frequently used in load carrying structures systems (Karmazínová *et al.* 2009a).

Steel and concrete have been intensively and extensively used as structural materials for bridges, buildings, and the other structures, in civil and architectural engineering. The theoretical analysis of the actual behaviour of modern structures from high strength concrete and steel are more frequently employed during design, realization and the utilization of building structures.

The combination of materials steel-concrete gives rise to the occurrence of special phenomena whose influence on structural reliability isn't at present commonly implemented in design. The load carrying capacity of a steel-concrete member is governed by several failure modes, such as failure of the steel element, failure of the concrete

element, failure of the interface between the two, and instability of the whole member (Fukumoto 1997).

Lately, parallel attention has been paid to better understanding of structural safety and reliability, see, e.g., (Kala 2007, 2008). For the purpose of aiming at these objectives, the probabilistic assessment can be also enlarged by the sensitivity analysis, see e.g. (Kala 2005, 2009). The sensitivity analysis identifies these quantities with dominant effect on reliability, which should be controlled with intensified accuracy during the manufacturing process. The most important results of experimental research of material and geometrical characteristics are published in (Melcher *et al.* 2004; Kala and Kala 2009). Using experimental data, based on their evaluation and comparison with numerical results it can lead to the verification and calibration of the created theoretical models. The general description of the verification and calibration methods in more detail can be found in numerous publications, see e.g. (Kala 2007; Karmazínová *et al.* 2009b).

In the presented paper, within the frame of theoretical analysis the load-displacement curves and load carrying capacities of compressions members were determined. Theoretical analysis is based on the creation of static models and their verification and calibration methods using parameters obtained experimentally. Results of experimental and theoretical analytical methods can serve

as the basis for more accurate design philosophy in the sense of specific design procedures of steel-concrete members which are given in normative rules, or for the innovation of general procedures and concepts with respect to the special character of investigated structural element.

**2. Theoretical model**

The subject of analysis is the ultimate limit state of a steel-concrete column of system length equal to its critical length,  $L = L_{cr} = 3$  m, in compression. The column consists of steel profile HEA140 encased with high strength concrete, see Fig. 1.

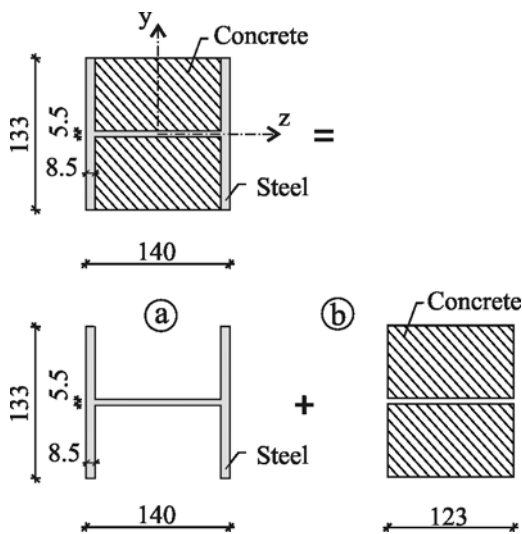

Fig. 1. Steel-concrete cross section

**2.1. Geometrical nonlinear solution**

The load  $F$  acting on the column consists of load  $F_S$ , which is carried by the steel section, and load  $F_C$ , which is carried by the concrete section, i.e.  $F = F_S + F_C$ . Let us assume that the strut is produced in the shape affine to eventual buckling, with deflection at mid length  $L/2$  denoted as  $e_0$ , see Fig. 2.

The maximum deflection mid-span of the strut  $e$ , which is loaded by axial force  $F$  in its elastic state, may be determined according to Timoshenko (Timoshenko and Gere 1961) as:

$$e = \frac{e_0}{1 - \frac{F}{F_{cr}}}, \tag{1}$$

where  $F$  is the load acting on the column and  $F_{cr}$  is Euler's critical force:

$$F_{cr} = \frac{\pi^2 EI}{L_{cr}^2}. \tag{2}$$

In accordance with article 6.7.3.1 (3) of standard EN 1994-1-1:2004, the effective elastic flexural stiffness

$EI$  of the steel-concrete column given according to the formula listed below may be used for short term loading:

$$EI = E_S \cdot I_S + K_E \cdot E_C \cdot I_C, \tag{3}$$

where  $I_S$  and  $I_C$  are second moments of area in the plane of bending of structural steel and concrete (without consideration to cracking),  $E_S$  is the modulus of the steel elasticity,  $E_C$  is the tangent modulus of the elasticity of concrete,  $K_E \cdot E_C \cdot I_C$  is the effective flexural stiffness of the concrete section.  $E_S \cdot I_S$  is the effective flexural stiffness of the steel section.

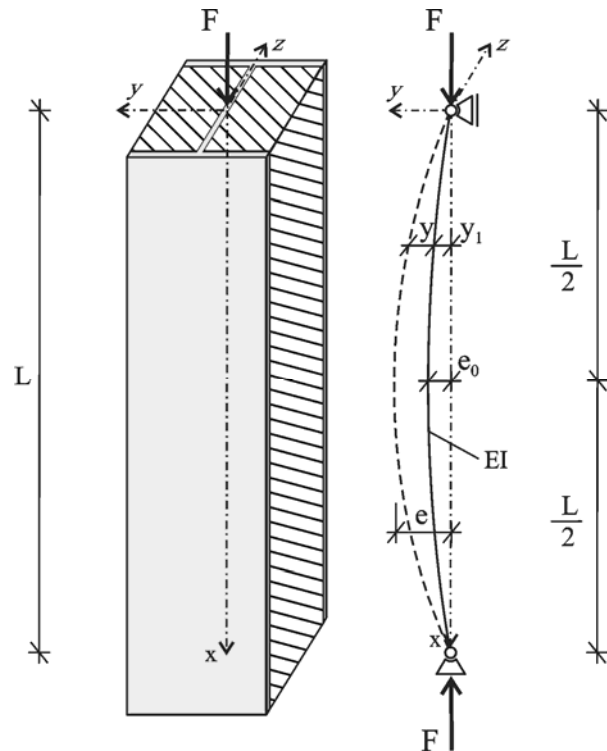

Fig. 2. Steel-concrete column under compression

Values of forces  $F_S$ ,  $F_C$  and parameter  $K_E$  can be obtained from the following deformation conditions:

1. Bending around the  $z$ -axis: Deflection mid-span of the strut in the direction of  $y$ -axis  $e$  is given as the deflection of the steel section  $e_S$ , which is equal to the deflection of the concrete section  $e_C$ ; i.e.  $e = e_S = e_C$ .
2. Compression in direction of  $x$ -axis: The compression of the steel section from  $F_S$  equals the compression of the concrete section from  $F_C$ .

With respect to (1) we can rewrite the first deformation condition as:

$$e = \frac{e_0}{1 - \frac{F}{F_{cr}}} = \frac{e_0}{1 - \frac{F_S}{F_{cr,S}}} = \frac{e_0}{1 - \frac{F_C}{F_{cr,C}}}, \tag{4}$$

where  $F_{cr,S}$  is Euler's critical force of the steel cross section

$$F_{cr,S} = \pi^2 \frac{E_S I_S}{L_{cr}^2}, \tag{5}$$

where  $F_{cr,C}$  is Euler's critical force of the concrete cross section

$$F_{cr,C} = \pi^2 \cdot K_E \frac{E_C I_C}{L_{cr}^2}. \quad (6)$$

The analysis that considers only the first deformation condition (and neglects the second deformation condition) was published in (Puklický and Kala 2009a, 2009b). The analysis requires substitution of the parameter  $K_E$  from standards EN 1994-1-1:2004 with the value  $K_E=0.6$ . This approach can be further expressed more precisely. The more precise solution would however require taking into account the second deformation condition with which the formula for the evaluation of parameter  $K_E$  can be derived:

$$K_E = \frac{I_S \cdot A_C}{I_C \cdot A_S}. \quad (7)$$

The load carried by the steel section  $F_S$  and the load carried by the concrete section  $F_C$  with parameter  $K_E$  can be determined from the above listed mathematical dependencies (where  $A_C$  is the area of concrete and  $A_S$  is the area of steel cross section):

$$F_S = F \frac{E_S \cdot I_S}{EI}; \quad (8)$$

$$F_C = F \cdot K_E \frac{E_C \cdot I_C}{EI}. \quad (9)$$

Stresses in the steel and concrete sections are determined according to the principles of elasticity. There is no shear force (and shear stress) at mid-length  $L/2$  of the strut. This simplifies the analysis of the load carrying capacity, see Fig. 3.

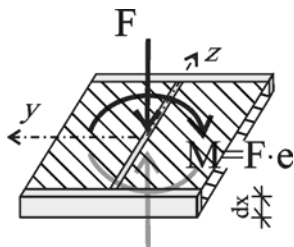

Fig. 3. Steel-concrete cross section in  $L/2$

The derivation of the computational formula for the elastic load carrying capacity is listed in detail in chapter 3 of article (Kala 2009). The formula of the elastic load carrying capacity is listed in (Kala 2009) in Box 1. The elastic load carrying capacity of the steel-concrete column is given as the minimum of the elastic load carrying capacities of the steel and concrete sections, which are determined as follows: (i) The elastic load carrying capacity of the steel member is given by the yield strength attained in the most stressed section. (ii) The elastic load carrying capacity of the concrete section is given as the cubic strength in the most compressed section or as 10% of the cubic strength in the most tensed part of the section.

### 2.2. Geometrical and material nonlinear solution

The maximum loading force under which the strut still exhibits elastic behaviour was denoted in the previous chapter as the elastic load carrying capacity. Further loading would lead to the ultimate load carrying capacity, resulting in permanent deformations of the strut. Bilinear kinematic material without strengthening (Fukumoto 1997) was considered for both the steel and concrete members, see Fig. 4.

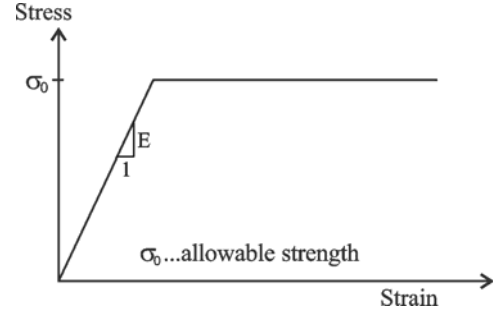

Fig. 4. Stress-strain dependence

Let us assume that the strut is loaded with force  $F_i$  with corresponding deformation  $e_i$  (if this force is equal to the elastic load carrying capacity then  $i = 1$ ). Let us choose a small load increment  $F_\Delta$ , such that  $F_{i+1} = F_i + F_\Delta$ . Let us focus on a section mid-length of the strut. Let us assume that the sectional characteristics are constant (size and shape of the plasticized cross section remains unchanged) in a loading step. Based on this assumption and with respect to (1) we can determine the elastic deformation increment  $e_{i+1}$  resulting from the small loading increment  $F_\Delta$ :

$$e_{i+1} = \frac{e_i}{1 - \frac{F_\Delta}{F_{cr}}}. \quad (10)$$

$F_{cr}$  is evaluated acc. to (2) for a strut with weakened section in  $L/2$ . Re-writing (10) we obtain the formula for the load increment  $F_\Delta$  in dependence to the increase in deformation:

$$F_\Delta = F_{cr} \frac{e_{i+1} - e_i}{e_{i+1}} = F_{cr} \frac{\Delta e}{e_{i+1}}. \quad (11)$$

As will be later illustrated, it is more practical to consider the parameter of deformation increment  $\Delta e = e_{i+1} - e_i$ , such that  $e_{i+1} \geq e_i$ .

Due to increase in deformation the moment condition of equilibrium from the already transferred load action  $F_i$  with corresponding deformation  $e_i$  is not fulfilled. The bending moment  $M_z$  resulting from force  $F_i$  is given in the  $i^{\text{th}}$  step as  $M_z = F_i \cdot e_i$ . This value must remain constant even after increase in deformation from  $e_i$  to  $e_{i+1}$ , i.e. it is necessary to decrease the transferred load  $F_i$  with a force, which we shall denote as  $F_{i,cor}$ . We need to thus determine this residual force  $F_{i,cor}$ , by which the

transferred load is decreased so that the moment condition of equilibrium is satisfied even after increase in deformation from  $e_i$  to  $e_{i+1}$ :

$$M_z = F_i \cdot e_i = (F_i - F_{i,cor}) \cdot e_{i+1}. \quad (12)$$

The force  $F_{i,cor}$  needed for the correction of the transferred loading due to increase in deformation  $\Delta e$  is expressed from (12) as

$$F_{i,cor} = F_i \frac{\Delta e}{e_{i+1}}. \quad (13)$$

The total increment of force can then be expressed from (11) and (13) as

$$\Delta F = F_{\Delta} - F_{i,cor} = (F_{cr} - F_i) \cdot \frac{\Delta e}{e_{i+1}}. \quad (14)$$

We thus obtain force  $F_{i+1} = F_i + \Delta F$  with corresponding deformation  $e_{i+1}$ . Internal forces and stresses at the mid-span of the steel-concrete column are determined from  $\Delta F$ , which is then added to the stress from the previous steps. In the next step we reduce the area of those segments where stresses exceeded the allowable stresses. The procedure is repeated analogously for subsequent steps  $i = 2, i = 3$ , etc.

$F_{cr}$  in equation (10) can be determined with sufficient accuracy under the presumption that the cross section is weakened along the whole length of the strut.

The maximum possible load, which the column is able to carry, is defined as the ultimate load carrying capacity. The ultimate load carrying capacity is approximately 3% higher than the elastic load carrying capacity. This is relatively insignificant. The theoretical models described in chapters 2.1 and 2.2 are sufficiently accurate. This was verified using the geometrical and material nonlinear solution with SHELL 181 elements of the ANSYS software, see e.g. (Kala and Kala 2009).

### 3. Experimental research

The theoretical analysis described in the previous chapter should present the most realistic description of the actual behaviour of real steel-concrete columns. For this reason results of the theoretical analysis were compared with results of the experimental verifications of the load carrying capacity and action of the columns (members) T16, T17, T18, consisting of steel profile HEA140 encased with concrete, under axial compression, which were performed at the Department of Metal and Timber Structures under the supervision of prof. Melcher and assoc. prof. Karmazínová. The tested elements T16, T17, T18 are the same specimens (Figs. 5 and 6).

One of the most important imperfections is the initial axis curvature of the strut. This was carefully measured in members T16, T17 and T18 at  $L/4$ , see Fig. 7. Measurements were performed in two mutually perpendicular directions with the samples freely placed in the horizontal position on the concrete floor. For our purpose one of the important information is the measurements of the initial axis strut curvature in the direction of axis  $y$ , see Fig. 7. The results of measurement depicted in Figs. 8

and 9 show that the shape of the initial curvature is very close to the shape of a half-wave of the sine function. This observation is in concordance with results of measurements of the initial axis curvature in (Fukumoto *et al.* 1976). Maximum values 2.99, -2.95, 2.92 were measured at the mid-length of the strut; see Fig. 8 and Fig. 9. Measured values are approximately equal to a thousandth of the critical length  $L_{cr} = 3$  m. With regard to the symmetry of the analyzed section, we can consider the maximum amplitudes with their absolute values.



Fig. 5. Loading test of member T17



Fig. 6. Loading test of member T17 - deflection at  $L/2$

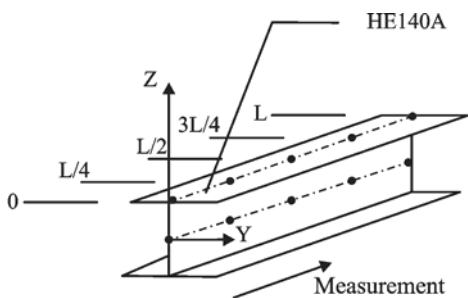

Fig. 7. Measurement of initial axis curvature

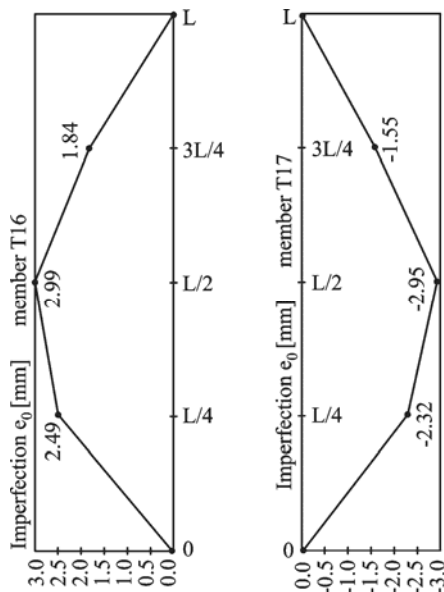

Fig. 8. Measurement of initial axis curvature

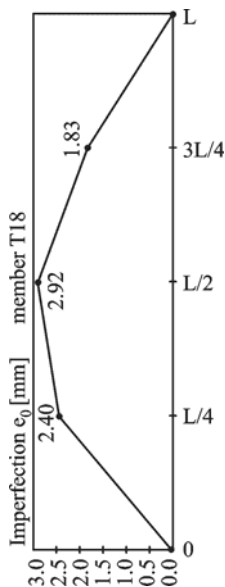

Fig. 9. Measurement of initial axis curvature

The measurement of the mechanical characteristics of concrete used in the production of the test members was performed in a similar manner. The average cubic strength of concrete evaluated from three samples on the

28th day had a value of 102.5 MPa, the average secant modulus of elasticity measured on the 28th day was 49.5 GPa. The yield strength was evaluated from 16 samples. The average yield strength is 455.81 MPa and standard deviation is 9.69 MPa. The geometrical characteristics of profile HE140A and modulus of elasticity of steel were not measured.

4. Verification of the theoretical analysis

The resulting dependences of “load action-deformation” of the three test samples T16, T17 and T18 present a description of measurements performed in three loading tests, see Fig. 10. In the comparative study of the theoretical analysis we shall consider the average values of the experimentally obtained material and geometrical characteristics described in the previous chapter. Variables  $h, b, t_1, t_2, E_S$ , which were not measured are taken into consideration by their nominal values, see Table 1.

Table 1. Input quantities

Quantity		Input values
Steel	Cross-s. height	$h$ 133 mm
	Flange width	$b$ 140 mm
	Web thickness	$t_1$ 5.5 mm
	Flange thick	$t_2$ 8.5 mm
	Yield strength	$f_y$ 455.81 MPa
	Young’s modulus	$E_S$ 210 GPa
Conc.	Cubic strength	$f_{cc}$ 102.5 MPa
	Secant modulus	$E_C$ 49.5 GPa
Imperfection		$e_0$ 2.95 mm

It is apparent from Fig. 10 that the theoretical analysis is in close agreement with results of the loading tests of samples T16, T17, and T18. The experimentally obtained results differ slightly. This may be due to imperfections that were not measured, for e.g. residual stress, rigidity of hinge joints (and corresponding buckling lengths), eccentricity of loading forces, deviations of sectional characteristics from their nominal values, small deviations of modulus of elasticity of steel and other material and geometrical characteristics, which were not taken into account by the mechanical tests.

The theoretical analysis yielded the elastic load carrying capacity of 1624.256 kN (end of the blue and beginning of the red branch) and the ultimate load carrying capacity (vertex of the loading branch) of 1663.145 kN, see Fig. 10. The deformation corresponding to the ultimate load carrying capacity of 20.8 mm is in close agreement with the experimentally obtained deformations 21.91 mm, 22.73 mm and 21.28 mm of samples T16, T17, T18. The plastic reserve of load carrying capacity is in agreement with the general conditions of 2.4%.

Change in the effective flexural stiffness of the theoretical analysis is also depicted in Fig. 10. The load carrying capacity 1663.145 kN corresponds to the state when the steel section is partially plasticized, whilst the concrete section is still in its elastic state. Further increase in deformation (black decreasing branch) leads to rapid plasticization in the most compressed part of the concrete section.



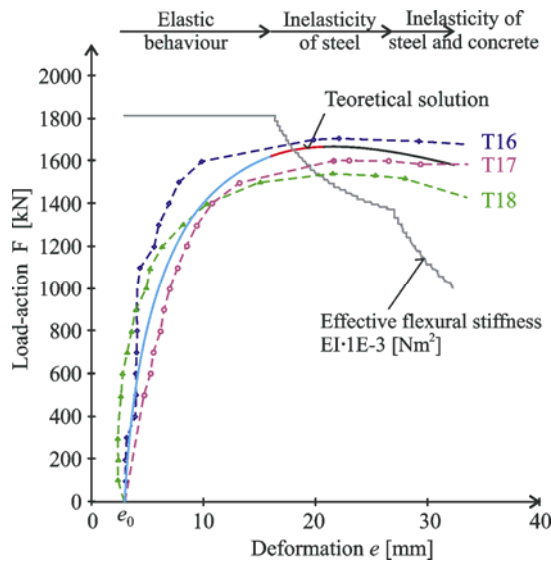

Fig. 10. Load-deflection curves

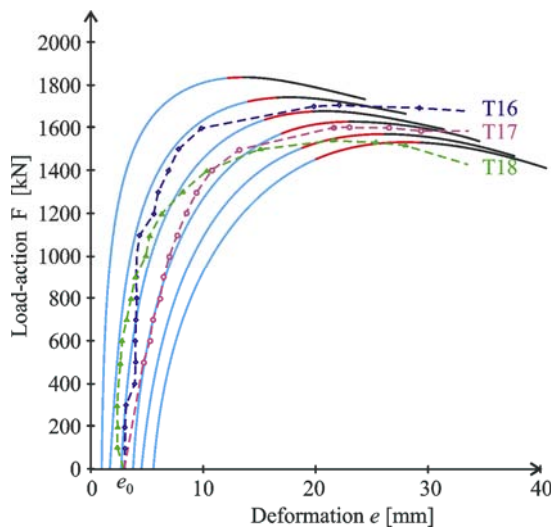

Fig. 11. Load-deflection curves

One of the significant imperfections, the variability of which has a large influence on the variability of the load carrying capacity is the amplitude of initial axis curvature of the strut. Practically the same imperfection value was measured for the three experimentally examined members. This is clearly visible in Fig. 10. The aim of subsequent theoretical studies is to determine how change in the amplitude of initial axis curvature  $e_0$  can influence change in the load-deflection curves and load carrying capacities see Fig. 11.

## 5. Stochastic analysis

Input material and geometrical characteristics are generally random variables. From the statistical point of view, more general conclusions can be made provided that objective information obtained from the evaluation of a higher number of samples taken from long term high level quality production is available. In the event that preceding empirical knowledge is available for random

variables, we can use the so-called Bayesian approach (Frangopol *et al.* 2008; Strauss *et al.* 2008). Other sources of information include statistically utilizable data from tolerance standards, which designate with which deviations from the nominal value or characteristic values elements may be produced.

### 5.1. Input random quantities

The first imperfection that we need to determine its statistical characteristics is the amplitude of initial axis curvature of the strut. Historically the tolerance limit of the initial axis curvature was considered as  $L/1000$ . Lately, based on studies and recommendations by (Sedlacek and Müller 2007), committee CEN/TC250/SC3 the value has been changed to  $L/750$ . The curvature of the steel part of the section, for which we can use the above listed recommendations, is decisive for our analysed steel-concrete column. The solved section is bi-axially symmetrical and hence we can assume that the mean value  $e_0$  is equal to zero, which is also stated in (Sedlacek and Müller 2007). We shall consider for the standard deviation that 95% of the realizations of the random variable are found within the tolerance limit of  $\pm L/750$ . Assuming a Gaussian distribution the standard deviation is  $S_{e_0} = L/1470$ .

The yield strength in Table 1 was statistically evaluated as the mean value obtained from 16 samples taken from three struts of steel S420, which were most probably obtained from one production line. We can expect that the deviation of yield strengths of samples obtained from one strut is relatively small in comparison with the deviation of yield strengths of samples obtained from various struts, where each sample is taken from one strut. Since more samples were taken from each strut, the evaluated standard deviation of the yield strength is smaller than if we took one sample from one strut (whereas it would be ideal to have a high number of struts at our disposal). The measurements therefore do not necessarily need to reflect the real deviation that would be obtained from a higher number of samples obtained from a higher number of struts over a long time interval. If we consider the average yield strength  $m_{fy} = 455.81$  MPa and the 5% quantile of the Gaussian probability distribution as 420 MPa, then the standard deviation has a value of  $S_{fy} = 21.771$  MPa. The standard deviation obtained in this manner is in concordance with long term monitored mechanical characteristics of structural steel. Mechanical characteristics of steel S235 were published in (Melcher *et al.* 2004; Strauss *et al.* 2006) and of steel S355 in (Kala *et al.* 2009).

The influence of the deviation of physical mechanical characteristic was taken into account by the variability of Young's modulus  $E$ . The mean value  $m_{E_0} = 210$  GPa was considered for each strut. The standard deviation was considered according to (Fukumoto *et al.* 1976) as the frequently listed value  $S_{E_0} = 12.6$  MPa.

The cubic strength of concrete of value 102.5 MPa in Table 1 was evaluated as the average value obtained from 3 samples produced from concrete C70/85. If the average value is  $m_{fc} = 102.5$  MPa and the 5% quantile is

85 MPa, then the standard deviation of the Gaussian distribution is  $S_{f_c} = 10.64$  MPa. Let us note that the variation coefficient of the cubic strength is approximately double than in the case of the yield strength.

Experimentally obtained statistical characteristics of the sectional geometry were published in (Kala et al. 2009). Let us assume that the variables  $h$ ,  $b$ ,  $t_1$ ,  $t_2$  have a Gaussian probability distribution and that their mean values are equal to their nominal values. Standard deviations will be considered according to (Kala et al. 2009). Secant modulus of elasticity is considered acc. to equation (6) published in (Puklický and Kala 2009a, b):

$$E_C = 22 \cdot \left( \frac{5}{6} \cdot \frac{f_{cc}}{10} \right)^{0.3} \cdot \Theta_{E_C} \quad (15)$$

Statistical characteristics of parameter  $\Theta_{E_C}$  were identified such that maximum agreement between the theoretical analysis and experiment is attained. Maximum agreement between statistical characteristics of the output of the theoretical analysis with the statistical characteristics of the experimental results is essential for the probabilistic analysis of reliability.

Input random variables are lucidly listed in Table 2. Statistical characteristics of the ultimate load carrying capacity determined from the theoretical analysis in chapter 2 and inputs from Table 2 agree closely to the statistical characteristics evaluated experimentally. It is necessary to note that only three members were measured, which is not enough to enable us make more general conclusions.

**Table 2.** Input random variables

Input values		Mean	St. deviation
Cross-s. height	$h$	133 mm	0.59 mm
Flange width	$b$	140 mm	1.38 mm
Web thickness	$t_1$	5.5 mm	0.22 mm
Flange thick.	$t_2$	8.5 mm	0.39 mm
Yield strength	$f_y$	455.81 MPa	21.771 MPa
Young's modulus	$E_S$	210 GPa	12.6 GPa
Cubic strength	$f_{cc}$	102.5 MPa	10.64 MPa
Quantities from (15)	$\Theta_{E_C}$	1.12	0.07
Imperfection $e_0$	$e_0$	0 mm	L/1470

Analysis and identification of input characteristics is generally involved during the process of securing structural reliability. Geometrical imperfections are important in slender members and thin walled steel structures, see e.g. (Kotelko et al. 2008; Melcher et al. 2009; Ungureanu et al. 2010; Gocál et al. 2010). In the case of massive concrete structures and geotechnical engineering works it is important to properly identify the material characteristics, see e.g. (Juozapaitis and Norkus 2007; Amšiejus et al. 2009). Sensitivity analysis may be used to determine which characteristics have the greatest influence in individual problems. Sensitivity analysis may either be stochastic or deterministic, depending on the type of analysed problem.

## 5.2. Statistical analysis

The curves of “load action-deformation” determined under the presumption that all variables in Table 2 are considered as random are depicted in Fig. 12. Obtained curves of “load action-deformation” are one of the main outputs describing the random characteristics of the ultimate limit state of the examined strut. The numerical simulation method LHS (McKey et al. 1979; Iman and Conover 1980), which is a method of type Monte Carlo, was used.

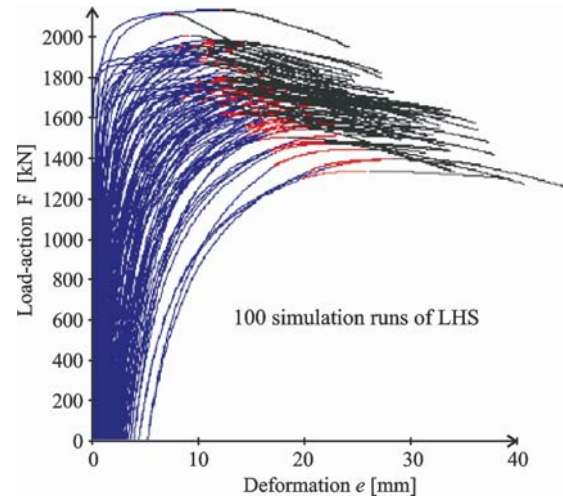

**Fig. 12.** Load-deflection curves

The most important outputs from the load action-deformation curves are the elastic and ultimate load carrying capacity and corresponding deformations. Random realizations of the elastic load carrying capacity for 100 000 simulation runs of the Monte Carlo method are depicted in Fig. 13. Random realizations of the ultimate load carrying capacity for 100 000 simulation runs of the Monte Carlo method are depicted in Fig. 14. Statistical characteristics of both experimentally and theoretically evaluated ultimate load carrying capacities are listed in Table 3.

**Table 3.** Ultimate load carrying capacity

Variant	Runs	Mean value	St. deviation
Theoretical	100 000	1734.1 kN	146.5 kN
Experiment	3	1617.4 kN	83.8 mm

Three ultimate load-carrying capacity observations from experiments are 1707.3 kN, 1603.4 kN, 1541.4 kN; the mean value is 1617.4 kN and standard deviation is 83.8 kN. The mean values 1734.1 kN and 1617.4 kN are closed, but standard deviations are different.

Let us remark that, if it were considered, in Table 2, no random  $e_0 = 2.95$  mm (see Fig. 10) and standard deviation of yield strength 9.69 MPa, the standard deviation of ultimate load carrying capacity as 81.1 kN and mean value as 1611.4 kN would be obtained; it is an excellent agreement with the results of the experiment. However, the standard deviation of variant Theoretical in Table 3 is higher, namely due to the necessarily non-zero random variability of the imperfection  $e_0$ .

The correlation between the elastic load carrying capacity and ultimate load carrying capacity is depicted in Fig. 15. Also very interesting are the dependencies between initial imperfections  $e_0$  and both load carrying capacities, see Fig. 16 and Fig. 17.

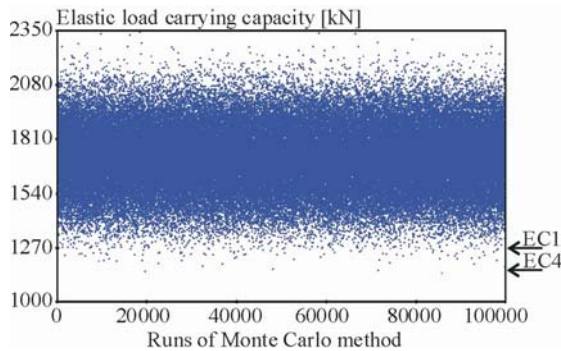

Fig. 13. Random elastic load carrying capacity

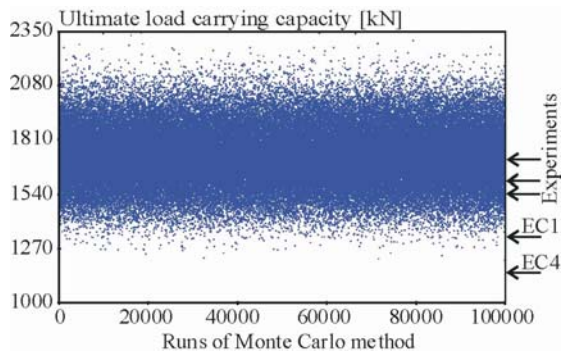

Fig. 14. Random ultimate load carrying capacity

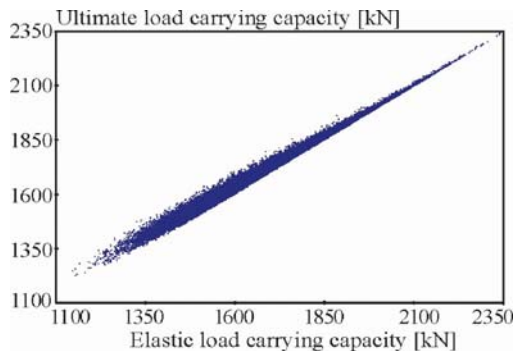

Fig. 15. Elastic vs. ultimate load carrying capacity

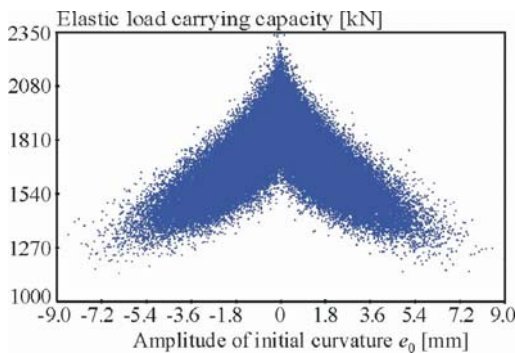

Fig. 16. Imp.  $e_0$  vs. elastic load carrying capacity

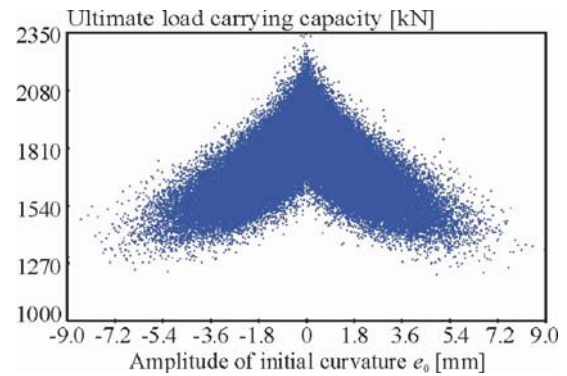

Fig. 17. Imp.  $e_0$  vs. ultimate load carrying capacity

### 6. Conclusion

Theoretical geometrical and material non-linear solutions were derived in the article. It is apparent from obtained results in Fig. 15 that the elastic load carrying capacity and ultimate load carrying capacity have a very strong correlation. Pearson correlation coefficient of value 0.996 was obtained. The lower the value, the greater the discrepancy between obtained results. The difference of load carrying capacities approaching the value of 1100 kN is approximately 6%. High values of load carrying capacities approaching the value of 2350 kN are without differences, see Fig. 15. This is due to the fact that the high values of the elastic and ultimate load carrying capacities were evaluated for members with small values of  $e_0$  (see Figs. 16 and 17), for which the plastic reserve of the section is not significant. Imperfection  $e_0$  is one of the dominant variables that influence the load carrying capacity (see Figs. 16, 17 and 12).

The design load carrying capacity for the target reliability index  $\beta_d = 3.8$  (standard EN 1990) is evaluated as 0.1% quantile. If the reliability of the member is sufficient, this value should be higher or equal to the design value evaluated acc. to standard EN 1994-1-1:2004 for axis of buckling  $y$ - $y$ , which is fulfilled, see EC4 in Figs. 13 and 14. In the event that the reliability is higher than the target, it is possible to consider optimization with regard to economy of design. Within the scope of modelling, the notions “optimization” and “reliability” has different meaning to different people (Atkočiūnas *et al.* 1997, 2008; Merkevičiūtė, Atkočiūnas 2006; Šešok *et al.* 2010; Jankovski and Atkočiūnas 2010). With the development of conceptions of the numerical analysis of advanced structures (Kaklauskas *et al.* 2008; Juozapaitis, Norkus 2007; Juozapaitis *et al.* 2008, 2010; Gribniak *et al.* 2010), these procedures can contribute to a qualitative improvement of the reliability analysis of structures. In this regard it is generally necessary point out publications dedicated to research problems in the field of building material and their technologies (Gailius and Kinuthia 2009; Kinuthia *et al.* 2009; Szwabowski and Łazniewska-Piekarczyk 2009). The economical criterion is however just one of the criteria of evaluation, which does not have to be the most important (Park *et al.* 2009). Discussions with leading world specialists show the need to take other aspects into consideration. Other aspects include elabo-



rateness of design and construction, maintenance, repairs, life span, insurance, material recycling, change of building function, etc.

It is necessary to note that creep, shrinkage and ageing effects, which have an effect on the ultimate limit state of the concrete section during ageing of the structure, were neglected during analysis. In general, these effects are taken into account of long-term deformation; see e.g. (Gribniak et al. 2007, 2008; Kaklauskas et al. 2009). Unfamiliarity of the behaviour of new materials and structures under real conditions can be gradually eliminated based on theoretical analysis of verified experimental research and modern methods of computational mechanics (Mang 2009; Mang et al. 2009). Obtained results may be utilized in standards for design. Further improvement of current ways for design will emanate from calibration methods, optimization principles and other rational approaches including the utilization of methods of the theory of probability, mathematical statistics and reliability theory.

The authors gratefully acknowledge the partial support provided by (i) the Czech Science Foundation within the projects of GAČR 103/08/0275 and GAČR 103/09/0597 and (ii) the research project CIDEAS 1M68407700001 (1M0579).

## References

- Amšiejus, J.; Dirgėlienė, N.; Norkus, A.; Žilionienė, D. 2009. Evaluation of soil shear strength parameters via triaxial testing by height versus diameter ratio of sample, *The Baltic Journal of Road and Bridge Engineering* 4(2): 54–60. doi:10.3846/1822-427X.2009.4.54-60
- Atkočiūnas, J.; Norkus, A.; Rimkus, L. 1997. Distortion in mechanics of elastic and elastic-plastic frames, *Computers & Structures* 62(5): 861–864. doi:10.1016/S0045-7949(96)00320-3
- Atkočiūnas, J.; Merkevičiūtė, D.; Venskus, A. 2008. Optimal shakedown design of bar systems: Strength, stiffness, and stability constraints, *Computers and Structures* 86(17–18): 1757–1768. doi:10.1016/j.compstruc.2008.01.008
- Fukumoto, Y.; Kajita, N.; Aoki, T. 1976. Evaluation of column curves based on probabilistic concept, in *Proc. of Int. Conference on Stability*, 1–37, Prelim. Rep., publ. by Gakujutsu Bunken Fukyu - Kai, Tokyo.
- Fukumoto, Y. 1997. *Structural Stability Design, Steel and Composite Structures*, Elsevier Science.
- Frangopol, D. M.; Strauss, A.; Kim, S. 2008. Use of monitoring extreme data for the performance prediction of structures: general approach, *Engineering Structures* 30(12): 3644–3653. doi:10.1016/j.engstruct.2008.06.010
- Gailius, A.; Kinuthia, J. 2009. Modern building materials and their investigation methods, *Journal of Civil Engineering and Management* 15(2): 129–130. doi:10.3846/1392-3730.2009.15.129-130
- Gribniak, V.; Kaklauskas, G.; Bačinskas, D. 2007. State-of-art review on shrinkage effect on cracking and deformations of concrete bridge elements, *The Baltic Journal of Road and Bridge Engineering* 2(4): 183–193.
- Gribniak, V.; Kaklauskas, G.; Bacinskas, D. 2008. Shrinkage in reinforced concrete structures: a computational aspect, *Journal of Civil Engineering and Management* 14(1): 49–60. doi:10.3846/1392-3730.2008.14.49-60
- Gribniak, V.; Kaklauskas, G.; Idnurm, S.; Bačinskas, D. 2010. Finite element mesh size effect on deformation predictions of reinforced concrete bridge girder, *The Baltic Journal of Road and Bridge Engineering* 5(1): 19–27. doi:10.3846/bjrbe.2010.03
- Gocál, J.; Vičan, J.; Hlinka, R.; Jošt, J. 2010. Laboratory tests of a typical fatigue prone riveted steel railway bridge structural detail, *Procedia Engineering* 2(1): 1761–1766. doi:10.1016/j.proeng.2010.03.189
- Juozapaitis, A.; Vainiunas, P.; Kaklauskas, G. 2006. A new steel structural system of a suspension pedestrian bridge, *Journal of Constructional Steel Research* 62(12): 1257–1263. doi:10.1016/j.jcsr.2006.04.023
- Iman, R. C.; Conover, W. J. 1980. Small sample sensitivity analysis techniques for computer models with an application to risk assessment, *Communications in Statistics – Theory and Methods* 9(17): 1749–842. doi:10.1080/03610928008827996
- Jankovski, V.; Atkočiūnas, J. 2010. SAOSYS Toolbox as MATLAB Implementation in the Elastic-Plastic Analysis and Optimal Design of Steel Frame Structures, *Journal of Civil Engineering and Management* 16(1): 103–121. doi:10.3846/jcem.2010.10
- Juozapaitis, A.; Norkus, A. 2007. Determination of rational parameters for the advanced structure of a pedestrian suspension steel bridge, *The Baltic Journal of Road and Bridge Engineering* 2(4): 173–181.
- Juozapaitis, A.; Norkus, A.; Vainiunas, P. 2008. Shape stabilization of steel suspension bridge, *The Baltic Journal of Road and Bridge Engineering* 3(3): 137–144. doi:10.3846/1822-427X.2008.3.137-144
- Juozapaitis, A.; Idnurm, S.; Kaklauskas, G.; Idnurm, J.; Gribniak, V. 2010. Non-linear analysis of suspension bridges with flexible and rigid cables, *Journal of Civil Engineering and Management* 16(1): 149–154. doi:10.3846/jcem.2010.14
- Kaklauskas, G.; Girdžius, R.; Bačinskas, D.; Sokolov, A. 2008. Numerical deformation analysis of bridge concrete girders, *The Baltic Journal of Road and Bridge Engineering* 3(2): 51–56. doi:10.3846/1822-427X.2008.3.51-56
- Kaklauskas, G.; Gribniak, V.; Bacinskas, D.; Vainiunas, P. 2009. Shrinkage influence on tension stiffening in concrete members, *Engineering Structures* 31(6): 1305–1312. doi:10.1016/j.engstruct.2008.10.007
- Kala, Z. 2005. Sensitivity analysis of the stability problems of thin-walled structures, *Journal of Constructional Steel Research* 61(3): 415–422. doi:10.1016/j.jcsr.2004.08.005
- Kala, Z. 2007. Stability problems of steel structures in the presence of stochastic and fuzzy uncertainty, *Journal of Thin-Walled Structures* 45(10–11): 861–865. doi:10.1016/j.tws.2007.08.007
- Kala, Z. 2008. Fuzzy probability analysis of the fatigue resistance of steel structural members under bending, *Journal of Civil Engineering and Management* 14(1): 67–72. doi:10.3846/1392-3730.2008.14.67-72
- Kala, Z. 2009. Sensitivity assessment of steel members under compression, *Engineering Structures* 31(6): 1344–1348. doi:10.1016/j.engstruct.2008.04.001
- Kala, Z.; Kala, J. 2009. Sensitivity analysis of stability problems of steel structures using shell finite elements and nonlinear computation methods, *WSEAS Transactions on Applied and Theoretical Mechanics* 4(3): 105–114, ISSN 1991-8747.

- Kala, Z.; Melcher, J.; Puklický, L. 2009. Material and geometrical characteristics of structural steels based on statistical analysis of metallurgical products, *Journal of Civil Engineering and Management* 15(3): 299–307. doi:10.3846/1392-3730.2009.15.299-307
- Karmazínová, M.; Melcher, J.; Röder, V. 2009a. Load carrying capacity of steel concrete compression member of high-strength materials, in *Proc. of Int. 9<sup>th</sup> Conf. Steel Concrete Composite and Hybrid Structures*, Leeds (UK), 239–244.
- Karmazínová, M.; Melcher, J.; Kala, Z. 2009b. Design of expansion anchors to concrete based on results of experimental verification, *Advanced Steel Construction* 5(4): 390–405.
- Kinuthia, J.; Snelson, D.; Gailius, A. 2009. Sustainable medium-strength concrete (CS-concrete) from colliery spoil in South Wales UK, *Journal of Civil Engineering and Management* 15(2): 149–157. doi:10.3846/1392-3730.2009.15.149-157
- Kotelko, M.; Kowal-Michalska, K.; Kubiak, T.; Kolakowski, Z.; Gradzki, R. 2008. Estimation of load carrying capacity of multi-layered plated structures, *Thin-walled Structures* 46(7–9): 1003–1010. doi:10.1016/j.tws.2008.01.037
- Mang, H. A. 2009. On contemporary computational mechanics, *Journal of Civil Engineering and Management* 15(1): 113–128. doi:10.3846/1392-3730.2009.15.113-128
- Mang, H. A.; Eberhardsteiner, J.; Hellmich, C.; Hofstetter, K.; Jäger, A.; Lackner, R.; Meinhard, K.; Müllner, H. W.; Pichler, B.; Pichler, C.; Reihnsner, R.; Stürzenbecher, R.; Zeiml, M. 2009. Computational mechanics of materials and structures, *Engineering Structures* 31(6): 1288–1297. doi:10.1016/j.engstruct.2009.01.005
- McKey, M. D.; Conover, W. J.; Beckman, R. J. 1979. A comparison of the three methods of selecting values of input variables in the analysis of output from a computer code, *Technometrics* 21(2): 239–245. doi:10.2307/1268522
- Melcher, J.; Kala, Z.; Holický, M.; Fajkus, M.; Rozlívka, L. 2004. Design characteristics of structural steels based on statistical analysis of metallurgical products, *Journal of Constructional Steel Research* 60(3–5): 795–808. doi:10.1016/S0143-974X(03)00144-5
- Melcher, J.; Škaloud, M.; Kala, Z.; Karmazínová, M. 2009. Sensitivity and statistical analysis within the elaboration of steel plated girder resistance, *Advanced Steel Construction* 5(2): 120–126. ISSN 1816-112X.
- Merkevičiūtė, D.; Atkočiūnas, J. 2006. Optimal shakedown design of metal structures under stiffness and stability constraints, *Journal of Constructional Steel Research* 62(12): 1270–1275. doi:10.1016/j.jcsr.2006.04.020
- Park, M.; Chu, Y.; Lee, H.-S.; Kim, W. 2009. Evaluation Methods for Construction Projects, *Journal of Civil Engineering and Management* 15(4): 349–359. doi:10.3846/1392-3730.2009.15.349-359
- Puklický, L.; Kala, Z. 2009a. Application of fuzzy analysis to stability problems of steel-concrete structural members, in *Proc. of the 2nd WSEAS Int. Conf. on Engineering Mechanics, Structures and Engineering Geology (EMSEGE '09)*, Rodos Island (Greece), 111–113, July 22-24, 2009, published by WSEAS Press.
- Puklický, L.; Kala, Z. 2009b. Application of uncertainty analysis to stability problems of steel-concrete structural members, *Engineering Structures and Technologies* 1(1): 44–49. doi:10.3846/skt.2009.05
- Sedlacek, G.; Müller, Ch. 2007. *Report for CEN/TC250/SC3 Geometrical tolerances in EN 1090-2 for long products used as columns in compression*, 16 November 2007, 9.
- Šešok, D.; Mockus, J.; Belevičius, R.; Kačeniauskas, A. 2010. Global optimization of grillages using simulated annealing and high performance computing, *Journal of Civil Engineering and Management* 16(1): 95–101. doi:10.3846/jcem.2010.09
- Strauss, A.; Kala, Z.; Bergmeister, K.; Hoffmann, S.; Novák, D. 2006. Technologische Eigenschaften von Stählen im europäischen Vergleich, *Stahlbau* 75, Januar 2006, Heft 1.
- Strauss, A.; Frangopol, D. M.; Kim, S. 2008. Use of monitoring extreme data for the performance prediction of structures: general approach, *Engineering Structures* 30(12): 3654–3666. doi:10.1016/j.engstruct.2008.06.009
- Szwabowski, J.; Łażniewska-Piekarczyk, B. 2009. Air-entrainment problem in self-compacting concrete, *Journal of Civil Engineering and Management* 15(2): 137–147. doi:10.3846/1392-3730.2009.15.137-147
- Timoshenko, S.; Gere, J. 1961. *Theory of Elastic Stability*. McGraw-Hill, New York.
- Ungureanu, V.; Kotelko, M.; Mania, R. J.; Dubina, D. 2010. Plastic mechanisms database for thin-walled cold-formed steel members in compression and bending, *Thin-Walled Structures* 48(10–11): 818–826. doi:10.1016/j.tws.2010.01.004
- EN 1994-1-1:2004. Eurocode 4: Design of composite steel and concrete structures – Part 1-1: General rules and rules for buildings.

## PLIENBETONIO ELEMENTŲ IŠ DIDELIO STIPRIO MEDŽIAGŲ STABILUMO PROBLEMAS

Z. Kala, L. Puklický, A. Omishore, M. Karmazínová, J. Melcher

### S a n t r a u k a

Straipsnyje pateikta plienbetonio pastatų elementų didžiausių ribinių būklių stochastinė analizė, analizuojama plienbetonio kolonų, sudarytų iš plieninių profiliuotųjų, padengtų didelio stiprio betonu, laikomoji galia gniuždant. Pirmoje straipsnio dalyje išvardytos kolonos teorinės laikomosios galios nustatymo prielaidos. Tamprumo ir plastiškumo principai taikyti įtempiams betono ir plieno skerspjuvniuose nustatyti. Nustatytos medžiagų ir geometrinių defektų statistinės charakteristikos, teorinės analizės rezultatai palyginti su eksperimentinių tyrimų rezultatais. Teorinės analizės metu gautų rezultatų statistinės charakteristikos patikrintos taikant iš eksperimentinių tyrimų gautus statistinius rodiklius. Pritaikytas skaitinis modeliavimas LHS ir Monte Karlo metodais, kurie įvertina pradinio defektų kintamumo įtaką. Parodyta plastiškumo atsargos naudojimo įtaka, nustatant analizuojamojo statramsčio laikomąją galią, pateikta pradinio statramsčio išlinkio pirminių geometrinių defektų įtaka laikomajai galiai.

**Reikšminiai žodžiai:** medžiagos, plienas, betonas, struktūra, defektai, susilpnėjimas, patikimumas.

**Zdeněk KALA.** Professor, Ph.D. Dept of Structural Mechanics, Brno University of Technology, Faculty of Civil Engineering. Author and co-author of 1 book, 3 textbooks and more than 180 scientific papers (120 published abroad), Member of Czech Society for Mechanics. Research interests: stability problems of steel structures, elastic-plastic analysis and optimisation of structures, including material and geometrical nonlinearities, numerical methods in structural mechanics, reliability methods.

**Libor PUKLICKÝ.** Ph.D. student. Dept of Structural Mechanics, Brno University of Technology, Faculty of Civil Engineering. Author and co-author of more than 20 scientific papers. Research interests: elastic-plastic analysis and optimisation of structures, including material and geometrical non-linearities, numerical methods in structural mechanics, reliability methods.

**Abayomi OMISHORE.** Ph.D. Dept of Structural Mechanics, Brno University of Technology, Faculty of Civil Engineering. Author and co-author of more than 30 scientific papers. Research interests: uncertainty analysis and optimisation of structures, numerical methods in structural mechanics, reliability methods.

**Marcela KARMAZÍNOVÁ.** Assoc. Prof. Ph.D. Dept of Metal and Timber Structures, Brno University of Technology, Faculty of Civil Engineering. She is author and co-author of more than 100 scientific and special papers. Research interests: structural stability, structural reliability and design of steel-concrete structures and experimental research.

**Jindřich MELCHER.** Professor, DSc Dept of Metal and Timber Structures, Brno University of Technology, Faculty of Civil Engineering. He is author and co-author of more than 170 scientific and special papers, lecture notes and textbooks (80 published abroad), Chartered Engineer, Active member in cooperation concerning the unified European documents within the framework of professional commissions of the CEN, IABSE member, Member of the Engineering Academy of Czech Republic. Research interests: stability problems, lateral buckling of beams and calculation of torsion stress were directly taken over into the text of the national standards CSN and STN for design of steel structures, reliability analysis of steel structures, experimental research. European prize of the ECCS 2001 (European Convention for Constructional Steelwork) for realized structures (head of a design team).